

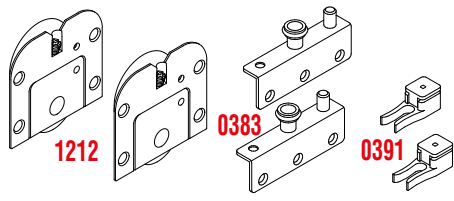

## KIT 0383-1212 - MAX 50 KG

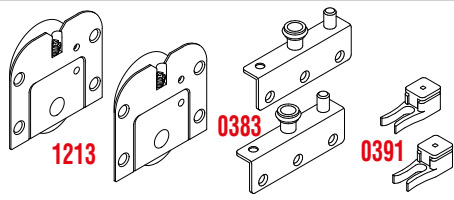



## KIT 0383-1213 - MAX 50 KG



### Legenda KIT / Kit Legend

<b>1212</b>	Carrello inferiore con rullo regolabile <i>Lower adjustable truck with roller</i>
<b>1213</b>	Carrello inferiore con cuscinetto regolabile <i>Lower adjustable truck with ball bearing</i>
<b>0383</b>	Guida superiore DX-SX <i>Right-left upper runner</i>
<b>0391</b>	Fermo superiore <i>Upper stopper</i>

### Legenda altri componenti Legend other items

<b>0390</b>		Profilo alluminio superior <i>Upper aluminium profile</i>
<b>0380</b>		Profilo alluminio inferiore <i>Lower aluminium profile</i>
<b>0300</b>		Profilo alluminio inferiore <i>Lower aluminium profile</i>

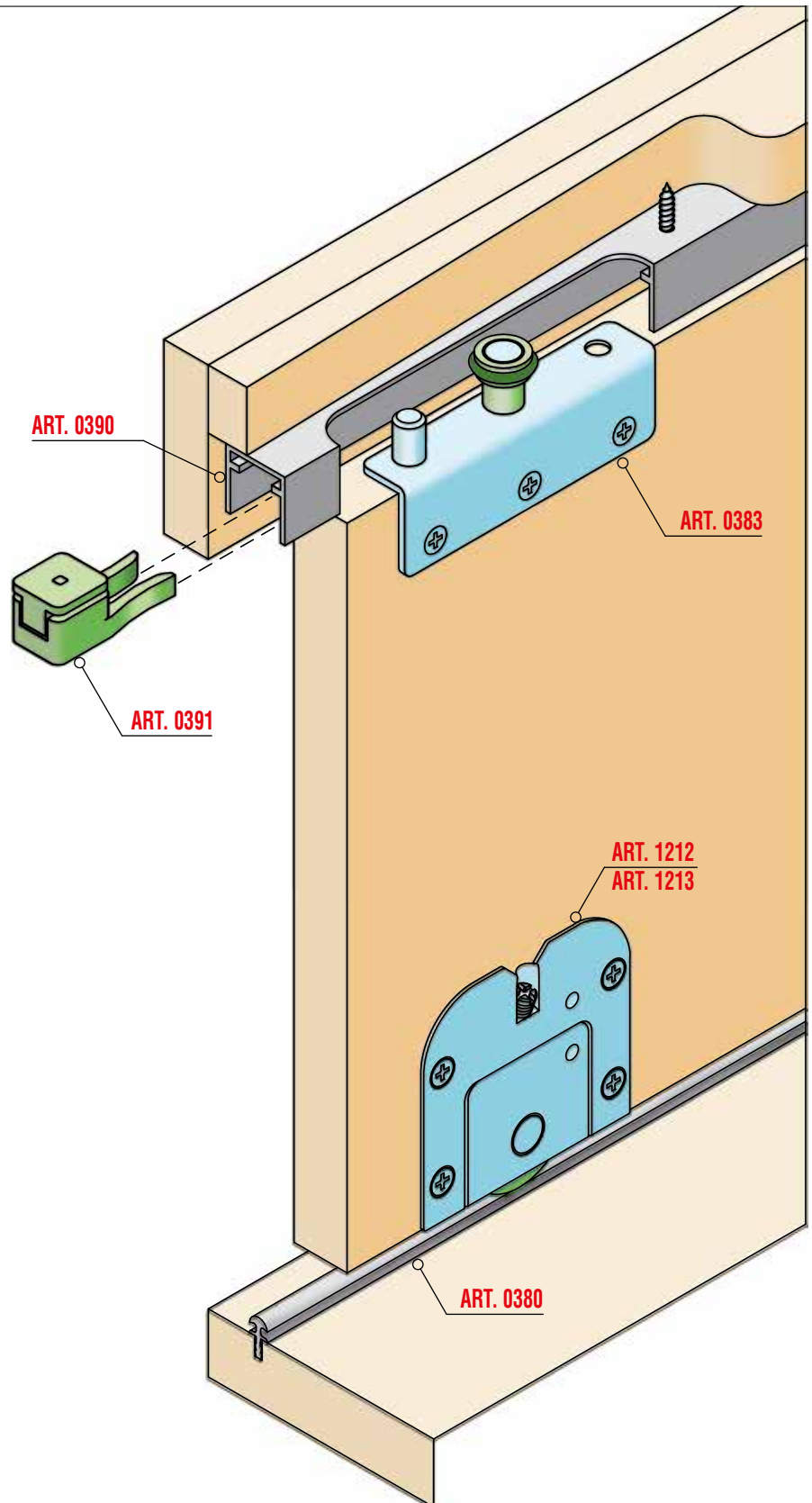



## Sezione verticale / Vertical section

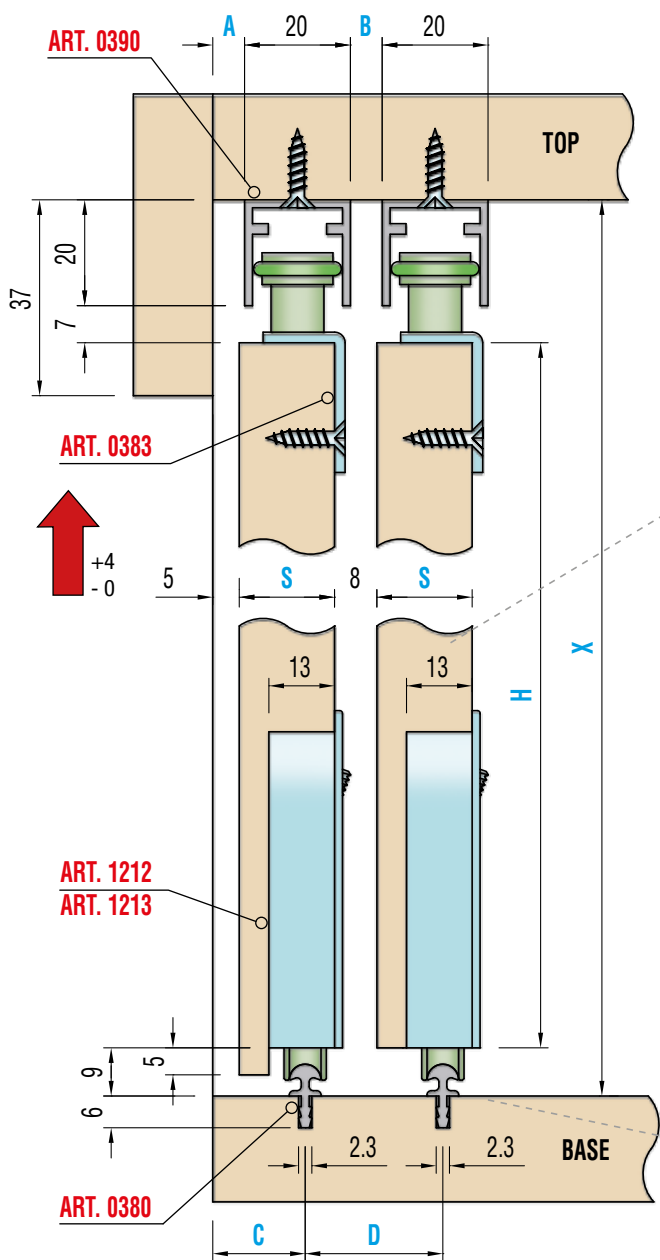

Peso massimo anta Kg. 50  
Maximum door weight Kg 50

<b>A</b> =	S* -12
<b>B</b> =	S* -12
<b>C</b> =	S* -0,5
<b>D</b> =	S* +8
<b>H</b> =	X -36

S\* (spessore / thickness)  
min.16

### Variante Special version

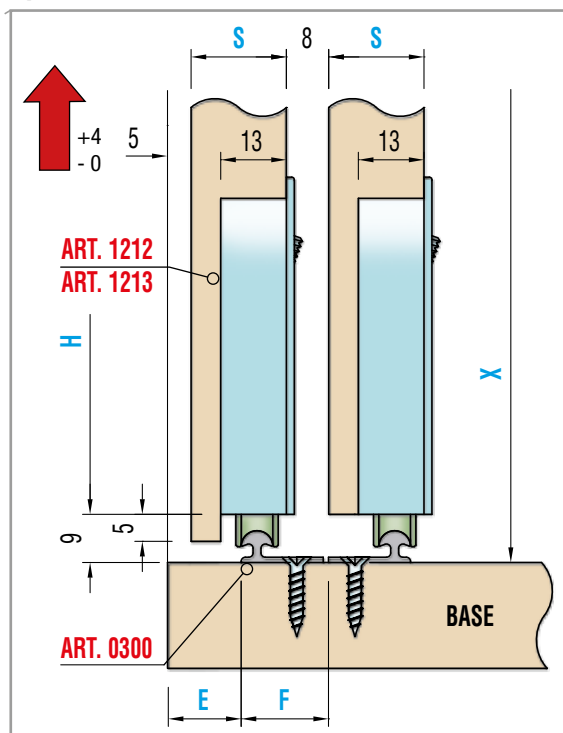

<b>E</b> =	S* -8,5
<b>F</b> =	S* -1,5
<b>H</b> =	X -36

## Schema Foratura ante / Doors drilling

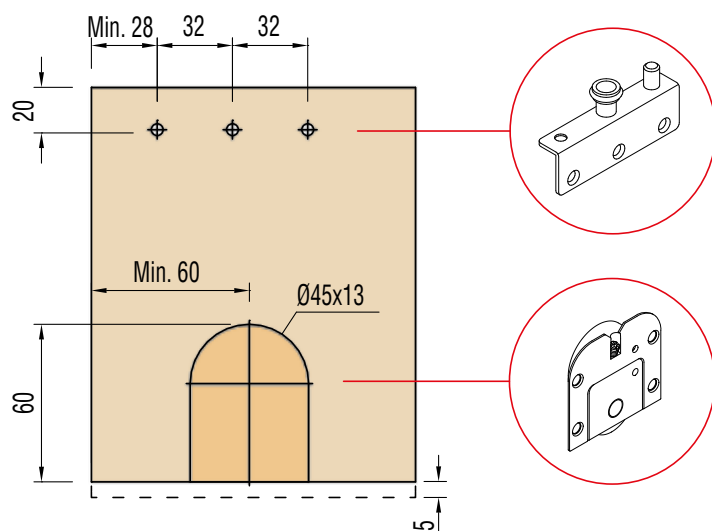

## Schema di montaggio / Assembling

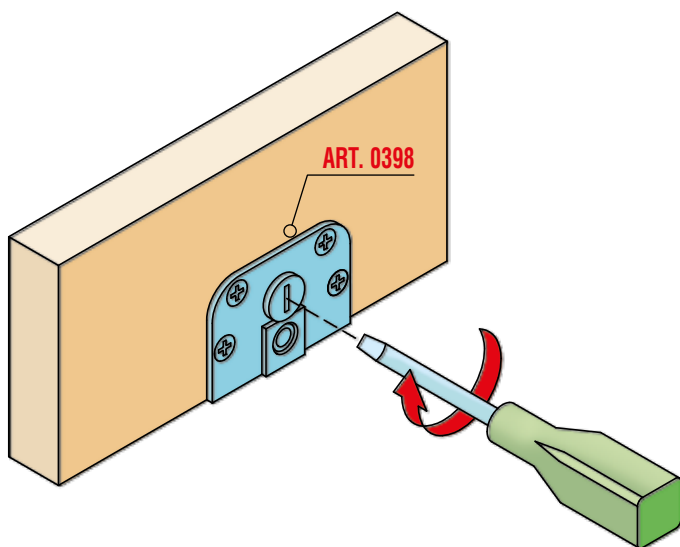

### REGOLAZIONE CARRELLO ART.0398 ADJUSTING TRUCK ART.0398

Montare l'anta sul mobile e se necessario, regolarla ruotando l'eccentrico con un cacciavite.

*Fit the door to the furniture piece, if necessary adjust it by turning the eccentric by screw-driver.*

### MONTAGGIO ANTE CON ART.0320 E 0390 FITTING OF DOORS CON ART.0320 E 0390

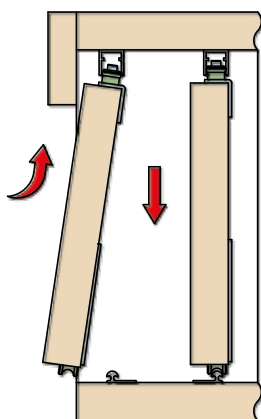

### MONTAGGIO ANTE CON ART.0211 E 0902 FITTING OF DOORS CON ART.0211 E 0902

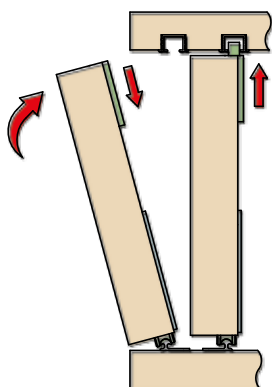

### MONTAGGIO ED USO DEI CARRELLI REGOLABILI ART.0304

1

Montare sull'anta i carrelli ART.0304 avvitando le viti nei fori asolati inferiori senza stringerle.

*Fit trucks ART.0304 to the door and turn the screws in the lower slots without tightening.*

2

Montare l'anta sul mobile e, se necessario, regolarla ruotando l'eccentrico con una chiave esagonale da mm 6.

*Fit the door to the furniture piece. If necessary, adjust it by turning the eccentric by means of a mm 6 hexagonal wrench.*

3

Infine stringere le viti precedentemente montate nei fori inferiori e bloccare il carrello avvitando ancora le viti nei fori superiori.

*Then tighten the screws previously inserted into the lower slots and lock the truck by tightening the screws in the upper slots.*

### FITTING AND USE THE ADJUSTABLE TRUCKS ART.0304

1

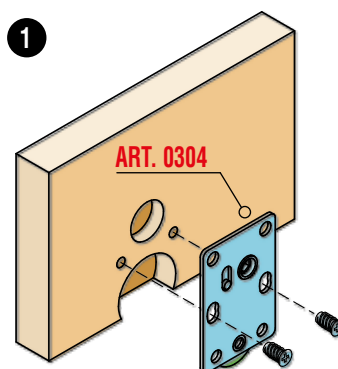

2

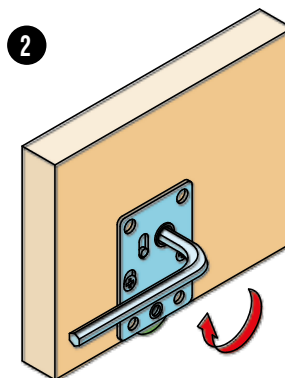

3

